

Digital Clamp Meter

Users Manual

Read this manual thoroughly before use

WARRANTY

This instrument is warranted to be free from defects in material and workmanship for a period of one year. Any instrument found defective within one year from the delivery date and returned to the factory with transportation charges prepaid, will be repaired, adjusted, or replaced at no charge to the original purchaser. This warranty does not cover expandable items such as battery. If the defect has been caused by a misuse or abnormal operating conditions, the repair will be billed at a nominal cost.

SAFETY INFORMATION



This meter has been designed according to IEC-61010 concerning electronic measuring instruments with a measurement category (CAT III 600 V) and Pollution degree 2.

Warning

To avoid possible electric shock or personal injury, follow these guidelines:

- Do not use the meter if it is damaged. Before you use the meter, inspect the case. Pay particular attention to the insulation surrounding the connectors.

- Inspect the test leads for damaged insulation or exposed metal. Check the test leads for continuity. Replace damaged test leads before you use the meter.
- Do not use the meter if it operates abnormally. Protection may be impaired. When in doubt, have the meter serviced.
- Do not operate the meter around explosive gas, vapor, or dust. Don't use it under wet condition.
- Do not apply more than the rated voltage, as marked on the meter, between terminals or between any terminal and earth ground.
- Before use, verify the meter's operation by measuring a known voltage.
- When servicing the meter, use only specified replacement parts.
- Use caution when working with voltage above 30V ac rms, 42V peak, or 60V dc. Such voltages pose a shock hazard.
- When using the probes, keep your fingers behind the finger guards on the probes.
- Connect the common test lead before you connect the live test lead. When you disconnect test leads, disconnect the live test lead first.
- Remove the test leads from the meter and the clamp from the clamped object before you open the battery cover or the case.

- Do not operate the meter with the battery cover or portions of the case removed or loosened.
- To avoid false readings, which could lead to possible electric shock or personal injury, replace the batteries as soon as the low battery indicator ("  " or "  ") appears.
- Do not touch any naked conductor with hand or skin.
- Do not use the test leads with other equipments.
- Do not hold the meter anywhere beyond the tactile barrier.
- Remaining endangerment:
When an input terminal is connected to dangerous live potential it is to be noted that this potential can occur at all other terminals!
- **CAT III** - Measurement Category III is for measurements performed in the building installation. Examples are measurements on distribution boards, circuit breakers, wiring, including cables, bus-bars, junction boxes, switches, socket-outlets in the fixed installation, and equipment for industrial use and some other equipment, for example, stationary motors with permanent connection to the fixed installation.
Do not use the meter for measurements within Measurement Categories IV.

Caution

To avoid possible damage to the meter or to the equipment under test, follow these guidelines:

- Disconnect circuit power and discharge all capacitors before testing resistance, diode or continuity.
- Use the proper function, range, and terminals for your measurements.
- Before turning the rotary switch to change functions, disconnect test leads and remove the clamp jaws from the circuit under test.

Electrical symbols

~ Alternating Current

≡ Direct Current

⎓ Both direct and alternating current

⚠ Caution, risk of danger, refer to the operating manual before use.

⚡ Caution, risk of electric shock.

⊥ Earth (ground) Terminal

CE Conforms to European Union directives

⊞ The equipment is protected throughout by double insulation or reinforced insulation.

⚡ Application around and removal from hazardous live conductors is permitted.

INTRODUCTION

This meter is compact 3 1/2-digit digital clamp meter for measuring DC and AC voltage, AC current, resistance, diode and continuity. It is easy to operate and is an ideal measurement tool.

GENERAL SPECIFICATION

Display: 3 1/2 digits LCD, with a max. reading of 1999

Overrange Indication: Only figure " 1 " shown on the display



Negative Polarity Indication: Negative sign " - " shown on the display automatically

Sampling Rate: About 3 times / sec

Jaw Opening Capability: About 2.7cm

Max. Measurable Conductor: About \varnothing 2.7cm

Battery: 3V button cell, CR2032 or equivalent, 3 pieces

Low Battery Indication: "  " (or "  ") shown on the display

Operating Environment: 0°C – 40°C, < 75%RH

Storage Environment: -10°C – 50°C, < 85%RH

Size: 185×80×37mm

Weight: about 180g (including battery)

SPECIFICATIONS

Accuracy is specified for a period of one year after calibration and at 18°C - 28°C, with relative humidity at 0% to 75%.

Accuracy specifications take the form of:

\pm ([% of Reading]+[number of Least Significant Digits])

AC Current

Range	Resolution	Accuracy	Overload Protection
20A	10mA	\pm (3% + 5)	600A (within 30 secs)
200A	100mA	\pm (2.5% + 5)	
600A	1A		

Frequency Range: 50Hz - 60Hz

Display: sine wave rms, average response

AC Voltage

Range	Resolution	Accuracy	Overload Protection
600V	1V	$\pm (1.2\% + 5)$	DC 600V AC 600V rms

Input Impedance: 9M Ω

Frequency Response: 40Hz - 400Hz

Display: sine wave rms, average response

Max. Allowable Input Voltage: 600V rms

DC Voltage

Range	Resolution	Accuracy	Overload Protection
600V	1V	$\pm (1.0\% + 5)$	DC 600V AC 600V rms

Input Impedance: 9M Ω .

Overload Protection: 600V rms

Resistance

Range	Resolution	Accuracy	Overload Protection
2000Ω	1Ω	± (1.2% + 5)	DC 250V AC 250V rms
200kΩ	100Ω	± (1.5% + 5)	

Continuity

Range	Description
	If the resistance is less than about 30Ω, the built-in buzzer will sound.

Diode

Range	Resolution	Description	Overload Protection
	1mV	The approx. forward voltage drop of the diode will be displayed. Open Circuit Voltage: about 2.5V	DC 250V AC 250V rms

STRUCTURE

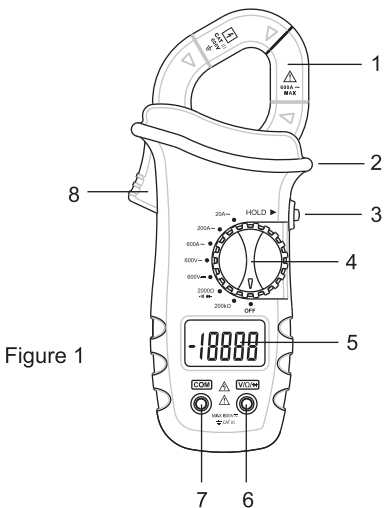

Figure 1

1. Jaws

Used to clamp the conductor for ac current measurements. To get more accurate reading, the conductor should be in the center of the jaws.

2. Tactile Barrier

Used to prevent finger from touching the conductor under test. Do not hold the meter anywhere beyond

the tactile barrier.

3. " HOLD " Button

Used to enter/exit Data Hold mode.

4. Function/Range Switch

Used to select the desired function and range as well as to turn on or off the meter.

To preserve battery life, set this switch in the "OFF" position when the meter is not in use.

5. Display

3 1/2-digit LCD, with a max. reading of 1999

6. " V/ Ω /▶ " Terminal

Plug-in connector for the red test lead for all measurements except ac current measurements.

7. " COM " Terminal

Plug-in connector for the black test lead for all measurements except ac current measurements.

8. Trigger

Used to open/close the jaws.

OPERATING INSTRUCTION

Data Hold Mode

Press the " **HOLD** " button to hold the present reading on the display, the display will show the symbol " **HOLD** " as an indication.

To exit the Data Hold mode, just press this button again. The symbol " **HOLD** " disappears

Measuring DC Voltage

1. Connect the black test lead to the " **COM** " terminal and the red test lead to the " **V/Ω/▶** " terminal.
2. Set the range switch in the 600V  range position.
3. Connect the test leads across the source or circuit to be tested.
4. Read the reading on the display. The polarity of the red test lead connection will be indicated as well.

Note:

To avoid electric shock to you or damages to the meter, do not apply a voltage higher than 600V between the terminals.

Measuring AC Voltage

1. Connect the black test lead to the " **COM** " terminal and the red test lead to the " **V/Ω/✚** " terminal.
2. Set the range switch in the 600V~ range position.
3. Connect the test leads across the source or circuit to be tested.
4. Read the reading on the display.

Note:

To avoid electric shock to you or damages to the meter, do not apply a voltage higher than 600V between the terminals.

Measuring AC Current

1. Set the range switch in the desired ac current range position.
2. Press the trigger and clamp the jaws around the conductor to be tested. Make sure that the jaws are perfectly closed.

Note:

- Each time only one conductor should be clamped.
- The conductor should be in the center of the jaws in order to get accurate reading.

3. Read the reading on the display.

Note:

1. To avoid electric shock, do not touch any naked conductor with hand or skin.
2. Remove all test leads from the meter before measurement.

Measuring Resistance

1. Connect the black test lead to the " **COM** " terminal and the red test lead to the " **V/ Ω /▶** " terminal .
2. Set the range switch in the desired resistance range position (" 2000Ω " or " $200k\Omega$ " position).
3. Connect the test leads across the object to be tested.
4. Read the reading on the display.

Note:

1. Before measurement, disconnect all power to the circuit to be tested and discharged all capacitors thoroughly.
2. Before the test leads are connected to the object to be tested, " 1 " will be displayed as overrange indication.

Continuity Test

1. Connect the black test lead to the " **COM** " terminal and the red test lead to the " **V/Ω/▶** " terminal.
2. Set the range switch in the **•))** position.
3. Connect the test leads across the circuit to be tested.
4. If the resistance is less than about 30Ω , the built-in buzzer will sound.

Note:

Before test, disconnect all power to the circuit to be tested and discharge all capacitors thoroughly.

Diode Test

1. Connect the black test lead to the " **COM** " terminal and the red test lead to the " **V/Ω/▶** " terminal.
(The polarity of the red test lead is positive " + " .)
2. Set the range switch in the **▶|** position.
3. Connect the red test lead to the anode of the diode to be tested and the black test lead to the cathode of the diode.
4. The display shows the approximate forward voltage drop of the diode. (Reading's unit is " mV " .)



MAINTENANCE

Periodically wipe the case with a damp cloth and mild detergent. Do not use abrasives or solvents.

Dirt or moisture in the terminals can affect readings. To clean the terminals, follow the steps below:

1. Turn the meter off and remove all test leads.
2. Shake out any dirt that may exist in the terminals.
3. Soak a new swab with alcohol. Work the swab around in each terminal.

BATTERY REPLACEMENT

When the low battery indicator "  " (or "  ") appears on the display, the button cells are low and must be replaced immediately.

To replace the button cells, remove the screw on the battery cover and remove the battery cover, replace the exhausted button cells with new button cells of the same type (3V, CR2032 or equivalent), make sure that the polarity connections are correct (see Figure 2). Reinstall the battery cover and the screw.

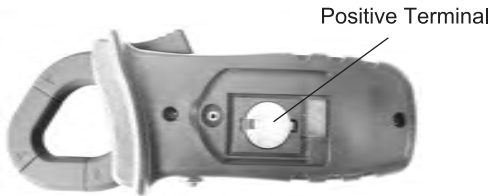

Figure 2

Warning:

To avoid electrical shock or personal injury, remove all test leads and any input signal before opening the battery cover or the case.

ACCESSORIES

Manual: 1 piece

Test Lead: 1 pair

NOTE

1. This manual is subject to change without notice.
2. Our company will not take the other responsibilities for any loss.
3. The contents of this manual can not be used as the reason to use the meter for any special application.

DISPOSAL OF THIS ARTICLE

Dear Customer,

If you at some point intend to dispose of this article, then please keep in mind that many of its components consist of valuable materials, which can be recycled.

Please do not discharge it in the garbage bin, but check with your local council for recycling facilities in your area.



